

NAO40X55X17-XL

Needle roller bearing

Schaeffler ID:
0507781450000

Needle roller bearings NAO, without ribs

X-life

Technical information

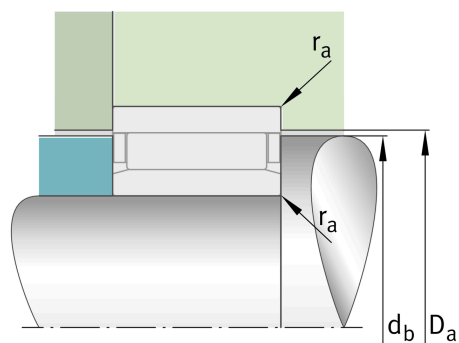
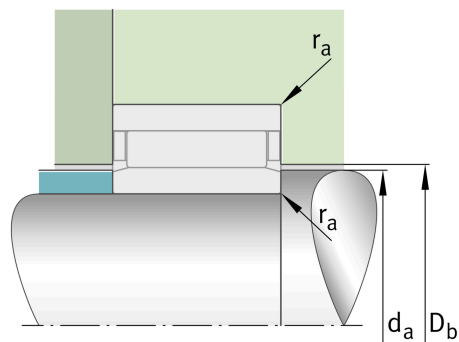
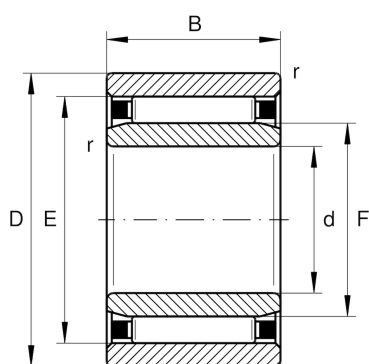

Main Dimensions & Performance Data

d	40 mm	Bore diameter
D	55 mm	Outside diameter
B	17 mm	Width
C_r	25,500 N	Basic dynamic load rating, radial
C_{0r}	46,000 N	Basic static load rating, radial
C_{ur}	7,300 N	Fatigue load limit, radial
n_G	10,300 1/min	Limiting speed
n_{gr}	5,900 1/min	Reference speed
	0.127 kg	Weight

Dimensions

F	45 mm	Raceway diameter inner ring
E	50 mm	Raceway diameter outer ring
r_{min}	0.3 mm	Minimum chamfer dimension
s	0.8 mm	Axial displacement

Mounting dimensions

d_a	44.5 mm	Mounting dimension
D_b	45.6 mm	Shoulder diameter axial guidance NK/housing
d_b	49.2 mm	Shoulder diameter axial guidance NK/shaft
D_a	50.5 mm	Shoulder diameter outer ring
$r_{a max}$	0.3 mm	Maximum recess radius

Temperature range

T_{min}	-30 °C	Operating temperature min.
T_{max}	120 °C	Operating temperature max.

